

CAN@net NT

100/200/420

USER MANUAL

4.01.0332.20000 2.0 en-US ENGLISH



Important User Information

Disclaimer

The information in this document is for informational purposes only. Please inform HMS Networks of any inaccuracies or omissions found in this document. HMS Networks disclaims any responsibility or liability for any errors that may appear in this document.

HMS Networks reserves the right to modify its products in line with its policy of continuous product development. The information in this document shall therefore not be construed as a commitment on the part of HMS Networks and is subject to change without notice. HMS Networks makes no commitment to update or keep current the information in this document.

The data, examples and illustrations found in this document are included for illustrative purposes and are only intended to help improve understanding of the functionality and handling of the product. In view of the wide range of possible applications of the product, and because of the many variables and requirements associated with any particular implementation, HMS Networks cannot assume responsibility or liability for actual use based on the data, examples or illustrations included in this document nor for any damages incurred during installation of the product. Those responsible for the use of the product must acquire sufficient knowledge in order to ensure that the product is used correctly in their specific application and that the application meets all performance and safety requirements including any applicable laws, regulations, codes and standards. Further, HMS Networks will under no circumstances assume liability or responsibility for any problems that may arise as a result from the use of undocumented features or functional side effects found outside the documented scope of the product. The effects caused by any direct or indirect use of such aspects of the product are undefined and may include e.g. compatibility issues and stability issues.

Table of Contents

Page

1	User Guide	3
1.1	Target Audience.....	3
1.2	Related Documents	3
1.3	Document History	3
1.4	Trademark Information	3
1.5	Conventions	4
2	Safety Instructions	5
2.1	General Safety Instructions	5
2.2	Intended Use.....	5
3	Scope of Delivery	6
4	Product Description	7
4.1	Features	7
4.2	Default Configuration	7
4.3	Operational Modes	8
4.4	Add-Ons for Customer Specific Expansions	10
5	Installation.....	11
5.1	Installing the Software	11
5.2	Installing the Hardware.....	11
5.3	Checking and Updating the Firmware	13
6	Configuration.....	15
6.1	Connecting Possibilities (CAN@net NT with PC).....	15
6.2	Basic Configuration	16
6.3	Configuration of Interface Modes (ASCII, VCI, ECI).....	20
6.4	Configuration of Bridge Modes (Local CAN, CAN-Eth-CAN)	21
6.5	Downloading the Configuration with Linux	22
6.6	Reset	23
6.7	Read and erase LOG File.....	24
7	Operation.....	25
7.1	Ethernet Port	25
7.2	Mini USB Port.....	25
7.3	Indicators	26

8	Default Network Settings	28
9	Default TCP/UDP Ports	28
10	Technical Data	28
11	Support/Return Hardware	29
11.1	Support	29
11.2	Return Hardware	29
12	Disposal	29
A	Regulatory Compliance	31
A.1	EMC Compliance (CE)	31
A.2	EMC Compliance (UKCA)	31
A.3	FCC Compliance Statement	31
A.4	Disposal and recycling	32
B	UL Ordinary Locations (Ord.Loc.)	33

1 User Guide

Please read the manual carefully. Make sure you fully understand the manual before using the product.

1.1 Target Audience

This manual addresses trained personnel who are familiar with CAN, CAN FD and the applicable national standards. The contents of the manual must be made available to any person authorized to use or operate the product.

1.2 Related Documents

Document	Author
Installation Guide <i>VCI Driver</i>	HMS
Software Design Guide <i>CAN@net NT 100/200/420 Generic Protocol for Gateway Mode</i>	HMS
User Manual <i>CAN-Gateway Configurator</i>	HMS
User Manual <i>CAN@net NT/CANbridge NT Lua ADK</i>	HMS
User Manual <i>CAN@net NT C-API</i>	HMS

1.3 Document History

Version	Date	Description
1.0	July 2016	First release
1.1	October 2016	Adjusted to new Ixxat CAN-Gateway Configurator
1.2	July 2017	Changes in configuration tool, added CAN@net NT 420
1.3	November 2017	Minor corrections
1.4	April 2018	Moved parts of the configuration to user manual of CAN-Gateway Configurator
1.5	January 2019	New CAN-Gateway-Configurator version
1.6	March 2019	Layout changes
1.7	March 2020	Added CAN@net NT 100 and new features, structural changes
1.8	December 2020	Added UL listing, adjusted links
1.9	June 2021	Added CAN controller clock frequency for CAN FD interfaces, changes in Config Tool, added UDP
2.0	December 2021	Added UKCA compliance information, information about Reset Target

1.4 Trademark Information

Ixxat® is a registered trademark of HMS Industrial Networks. All other trademarks mentioned in this document are the property of their respective holders.

1.5 Conventions

Instructions and results are structured as follows:

- ▶ instruction 1
- ▶ instruction 2
 - result 1
 - result 2

Lists are structured as follows:

- item 1
- item 2

Bold typeface indicates interactive parts such as connectors and switches on the hardware, or menus and buttons in a graphical user interface.

```
This font is used to indicate program code and other
kinds of data input/output such as configuration scripts.
```

This is a cross-reference within this document: [Conventions, p. 4](#)

This is an external link (URL): www.hms-networks.com

Safety advice is structured as follows:

	<p>Cause of the hazard!</p> <p>Consequences of not taking remediate action.</p> <p>How to avoid the hazard.</p>
---	---

Safety signs and signalwords are used dependent on the level of the hazard.

 *This is additional information which may facilitate installation and/or operation.*

	<p>This instruction must be followed to avoid a risk of reduced functionality and/or damage to the equipment, or to avoid a network security risk.</p>
---	--

	<p>Caution</p> <p>This instruction must be followed to avoid a risk of personal injury.</p>
---	--

	<p>WARNING</p> <p>This instruction must be followed to avoid a risk of death or serious injury.</p>
---	--

2 Safety Instructions



Risk of interference to radio and television if used in office or home environment!

Use exclusively included accessories. Use exclusively shielded cables.

Make sure that the shield of the interface is connected with the device plug and the plug on the other side.



Connection disturbance possible if extension cable or longer cable is used!

HMS recommends connecting the interface directly with the included cable or via an active USB hub to the computer according to the USB specification.

2.1 General Safety Instructions

- ▶ Protect product from moisture and humidity.
- ▶ Protect product from too high or too low temperature (see [Technical Data, p. 28](#)).
- ▶ Protect product from fire.
- ▶ Do not paint the product.
- ▶ Do not modify or disassemble the product. Service must be carried out by HMS Industrial Networks.
- ▶ Store products in dry and dust-free place.

2.2 Intended Use

The components are used to connect computer systems to CAN and CAN FD networks and to connect the networks with each other. They are intended for installation on standard DIN rail.

3 Scope of Delivery

Included in scope of delivery:

- CAN@net NT
- 1 x power connector
- 2 x CAN connector (with CAN@net NT 200)
4 x CAN connector (with CAN@net NT 420)
- User Manual *CAN@net NT*
- Installation Guide *VCI Driver*
- Mini USB cable

The following is available for download on the CAN@net NT support pages on www.ixxat.com/support-bridges-gateways:

- CAN-Gateway Configurator
- VCI driver
- User Manual *CAN-Gateway Configurator for CAN@net NT and CANbridge NT*
- Software Design Guide *CAN@net NT 100/200/420 Generic Protocol for Gateway Mode*
- User Manual *CAN@net NT/CANbridge NT Lua ADK*
- User Manual *CAN@net NT C-API ixcan*

4 Product Description



To use all features the latest version of the CAN-Gateway Configurator as well as the latest firmware of the CAN@net NT must be installed. For documentation of firmware versions below V6 contact lxxat support.

The CAN@net NT hardware provides connectivity to Ethernet and CAN networks with various operational modes. The CAN@net NT 420 additionally is capable of CAN FD. The application firmware provides functions to access a CAN bus from virtually every Ethernet host. The CAN@net NT provides message filtering, based on CAN identifiers, for Bridge and Gateway mode in the direction from CAN system to TCP/IP network. In the Gateway mode the filter can be configured by ASCII commands. In the Bridge mode the configuration tool is used to configure the filter. With the VCI driver the CAN@net NT can be used as a PC interface.

4.1 Features

- CAN@net NT 100: 1 x CAN connections (D-Sub 9 connector)
- CAN@net NT 200: 2 x CAN connections (terminal adapters)
- CAN@net NT 420: 4 x CAN connections (terminal adapters), via the CAN-Gateway Configurator two connections can be switched between Classic CAN and CAN FD
- 1 x RJ45 Ethernet port, 10/100 Mbit/s
- 1 x mini USB 2.0 port, high-speed
- CAN/CAN FD according to ISO 11898-1:2015
- CAN high speed according to ISO 11898-2:2016
- configuration via USB or Ethernet
- platform independent due to ASCII protocol
- With the CAN-Gateway Configurator a configuration can be created, modified, written to and read from the target device via USB or Ethernet connection.

The configuration of the following features are described in detail in the User Manual *CAN-Gateway Configurator CANbridge NT & CAN@net NT 100/200/420*:

- Classic CAN/CAN FD ID filtering (mapping)
- Classic CAN to CAN FD mapping and CAN FD to Classic CAN mapping (with NT 420)
- J1939 mapping
- cyclic transmission of CAN messages
- MQTT and syslog functionality
- command line program CANGWfile (available for Windows and Linux)
- action rules via if-this-action-then-that-event functionality
- remote access via ASCII protocol

4.2 Default Configuration

By default the CAN@net NT is configured as VCI interface and can be used as PC interface with Windows.

4.3 Operational Modes

4.3.1 ASCII Gateway Mode

In the Gateway mode, the CAN@net NT is directly hooked to the local intranet or internet (firewall needed). This allows a TCP/UDP host within the reach of this intranet or internet to connect to the CAN@net NT and gain control of the CAN system. The Ethernet network can exchange commands and CAN messages using the ASCII protocol. The CAN@net NT relays the commands and messages to the CAN bus and vice versa.

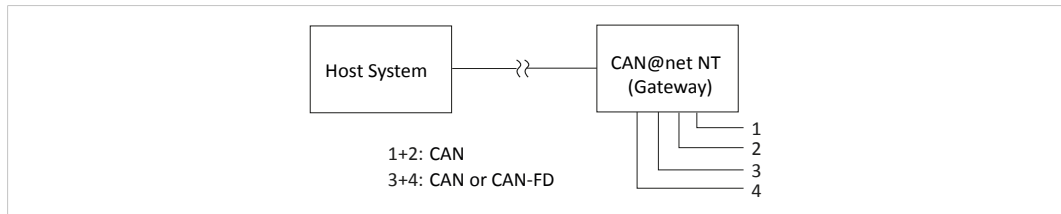

Fig. 1 Gateway mode

For information about the communication in Gateway mode and commands that are used to exchange CAN messages see Software Design Guide *CAN@net NT 100/200/420 Generic Protocol for Gateway Mode* on CAN@net NT support pages on www.ixxat.com/support-bridges-gateways.

4.3.2 Bridge Modes

A single device can be used as Local CAN Bridge, which allows to map individual messages from and to each CAN port of the device. The CAN-Ethernet-CAN Bridge mode allows to connect CAN systems over an Ethernet network, for example the local intranet or the internet (firewall needed). Minimum two devices are required for a CAN-Ethernet-CAN Bridge. One must be configured as master and one as slave.

For detailed descriptions of the features in the different modes (e.g. MQTT, Action Rules, cyclic transmission) and information about the configuration see User Manual *CAN-Gateway Configurator CANbridge NT & CAN@net NT 100/200/420* CAN@net NT support pages on www.ixxat.com/support-bridges-gateways.

Possible Bridge Modes with CAN@net NT 100:

- Local CAN Bridge
- CAN-Ethernet-CAN Bridge with 2 devices

Possible Bridge Modes with CAN@net NT 200:

- Local CAN Bridge
- CAN-Ethernet-CAN Bridge with 2 devices

Possible Bridge Modes with CAN@net NT 420:

- Local CAN Bridge
- CAN-Ethernet-CAN Bridge with 2 devices
- CAN-Ethernet-CAN Bridge with 3 devices
- CAN-Ethernet-CAN Bridge with 4 devices

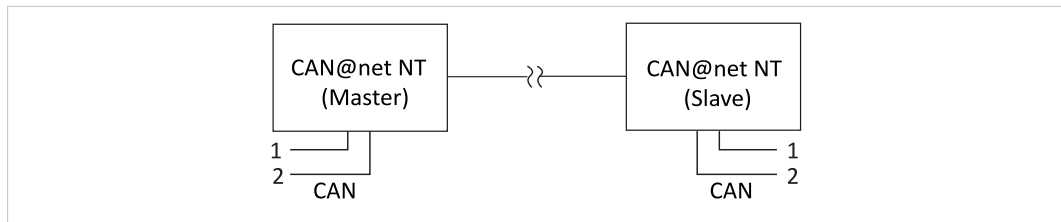

Fig. 2 CAN-Ethernet-CAN Bridge with 2 devices (NT 200)

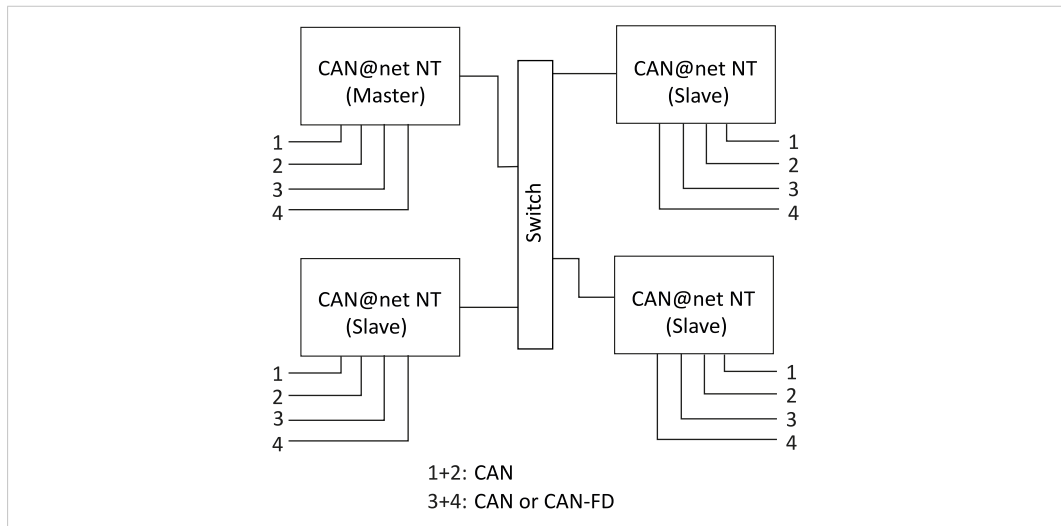

Fig. 3 CAN-Ethernet-CAN Bridge with 4 devices (NT 420)

4.3.3 VCI Interface Mode



The VCI interface mode is only possible via Ethernet.

With the VCI driver the CAN@net NT can be used as a PC interface with Windows. All VCI-based Ixxat tools as well as customer-specific applications based on the VCI driver can be used. The VCI driver offers the possibility to communicate with up to 128 CAN@net NT devices via LAN or internet. The CAN@net NT 420 additionally is capable of CAN FD.

For information about the communication in the VCI mode and commands that are used to exchange CAN messages see Software Design Guides in the VCI download package (available on www.ixxat.com/driver-windows).

4.3.4 ECI Interface Mode



The ECI interface mode is only possible via Ethernet.

With the ECI driver the CAN@net NT can be used as a PC interface with Linux. All ECI-based Ixxat tools as well as customer-specific applications based on the ECI driver can be used. The ECI driver offers the possibility to communicate with up to 32 CAN@net NT devices via LAN or internet. The CAN@net NT 420 additionally is capable of CAN FD.

For information about the communication in the ECI mode and commands that are used to exchange CAN messages see Software Design Guides in the ECI download package (available on the product support pages on www.ixxat.com/driver-linux).

4.4 Add-Ons for Customer Specific Expansions

4.4.1 Lua ADK

With the Lua Application Development Kit customer specific Lua scripts can be executed on the CAN@net NT in operational modes Local Bridge or CAN-Eth-CAN bridge. By using the Lua ADK for handling and processing of communication data the functionality of the standard application can be expanded.

For more information about the Lua ADK see User Manual *CAN@net NT/CANbridge NT Lua ADK* on the product support pages on www.ixxat.com/support-bridges-gateways.

4.4.2 C-API ixcan

The CAN API for C uses the ASCII protocol interface to access the CAN@net NT. The C-API ixcan converts the API calls into corresponding ASCII commands according to the ASCII Gateway Mode of the CAN@net NT. With the application that uses the C-API ixcan the CAN@net NT can be accessed exclusively or in shared access with a Bridge configuration.

For more information about the C-API ixcan see User Manual *CAN@net NT C-API ixcan* on the product support pages on www.ixxat.com/support-bridges-gateways.

5 Installation

5.1 Installing the Software

To create a configuration for the CAN@net NT, the CAN-Gateway Configurator running on a Windows system and the Ixxat VCI driver are needed.



The VCI driver is constantly improved and expanded! Check if a newer version is available on www.ixxat.com/driver-windows.



The CAN-Gateway Configurator and the device firmware are constantly improved and expanded! Check if newer versions are available within the product support pages on www.ixxat.com/support-bridges-gateways.

- ▶ Install the latest VCI driver on a Windows computer (see Installation Guide *VCI Driver*).
- ▶ Download the *CAN-Gateway Configurator CANbridge NT & CAN@net NT 100/200/420* package from the product support pages on www.ixxat.com/support-bridges-gateways.
- ▶ Start the **Ixxat CanGWconfig Setup**.
 - Installation wizard starts automatically.
- ▶ Follow the instructions in installation program.
 - By default the CAN-Gateway Configurator is stored in `C:\Program Files\HMS\Ixxat CAN-Gateway Configurator V6`.
 - The examples for (LUA, ASCII, C-API ixcan, and configuration) are stored in `C:\Users\Public\Documents\HMS\Ixxat CAN-Gateway Configurator\Examples`.
- ▶ Check the firmware version in `C:\Users\Public\Documents\HMS\Ixxat CAN-Gateway Configurator\Examples\firmware` and check if a newer firmware version is available on www.ixxat.com/support-bridges-gateways
- ▶ If newer firmware version is available, update the firmware (see [Updating the Device Firmware, p. 13](#)).
- ▶ In Windows Start menu open folder **Ixxat CANGWconfig** and start **CAN-Gateway Configurator V6**.

5.2 Installing the Hardware



Fig. 4 Connectors



The CAN@net NT 100 has one D-Sub 9 CAN connector on the front.

1	CAN 1 (CAN@net NT 200/420)
2	CAN 2 (CAN@net NT 200/420)
3	Power connector
4	CAN 3 (CAN@net NT 420)
5	CAN 4 (CAN@net NT 420)

- ▶ Make sure that the cross-sectional area of the cable is larger than or equal to 0.14 mm² resp. 25 AWG.
- ▶ To remove the connector, use screwdriver or similar tool.
- ▶ Connect the CAN cables.
- ▶ Connect the power supply.
- ▶ Plug the connector into the housing.

The shield of the CAN connector is connected to the device ground and the PE on the back of the device (DIN rail) via a 1 MΩ resistor and a 10 nF capacitor. To achieve highest interference immunity, ground the shield of the CAN cable on one side.

5.2.1 Power Connector

Pin Allocation

Pin no.	Signal
1	V+ (+9 V to +36 V DC)
2	V-
3	—
4	—



5.2.2 CAN and CAN FD Connectors

Pin Allocation of Terminal Adapters

Pin no.	Signal
1	CAN high
2	CAN low
3	CAN GND
4	Shield



If a D-Sub 9 connector is used for the terminal adapters, observe the pin allocation of the D-Sub 9 connector.

Pin Allocation of D-Sub 9 Connector (CAN@net NT 100 and Adapter)

Pin no.	Signal
1	—
2	CAN low
3	CAN GND
4	—
5	Shield
6	—
7	CAN high
8	—
9	—

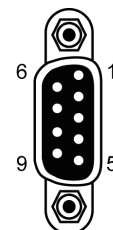

5.3 Checking and Updating the Firmware

5.3.1 Checking the Device Firmware

- ▶ Make sure, that the latest VCI driver is installed.
- ▶ Make sure, that the device is correctly connected to the host computer and to power supply.
- ▶ Make sure that the latest CAN-Gateway Configurator is installed (check within product support pages on www.ixxat.com/support-bridges-gateways).
- ▶ Start the Ixxat CAN-Gateway Configurator.
- ▶ Open menu **Scan** and select **All Ixxat devices**.
 - Connected devices and firmware version of the devices are shown.

5.3.2 Updating the Device Firmware



Whether updating is permitted via Ethernet or a password is needed, is defined in the security settings of the CAN-Gateway Configurator. The default password is IXXAT. For more information see user manual *CAN-Gateway Configurator*.



The firmware is constantly improved and expanded! Check if a newer firmware version is available within the product support pages on www.ixxat.com/support-bridges-gateways.

To use all features the latest firmware versions of the CAN-Gateway Configurator and of the CAN@net NT must be installed.

If the current firmware of the CAN@net NT in use is V4 or older:



- ▶ See update package on the product support pages on www.ixxat.com/support-bridges-gateways for information about updating to V5 or contact Ixxat support.

If the current firmware of the CAN@net NT in use is V5 or V6:

- ▶ Check if newer firmware is available on the product support pages on www.ixxat.com/support-bridges-gateways.
- ▶ Download and unzip the update package.
- ▶ Make sure, that the device is connected to power supply.
- ▶ Connect the device to the computer via USB.
- ▶ Make sure that the latest CAN-Gateway Configurator is installed (check within product support pages on www.ixxat.com/support-bridges-gateways).
- ▶ Start the CAN-Gateway Configurator.
- ▶ In drop down list **Select device type** select the device in use.
- ▶ In drop down list **Select device version** select the current firmware version of the device **V5** or **V6**.



The device is only found if the selected firmware version matches the firmware version of the connected device.

- ▶ Scan for devices with button **Scan**  and select the device in use in the combo box **Target Device**.
- ▶ Click button **Connect** .

-
- ▶ Open menu **Target** and select **Read configuration from target**.
 - ▶ Save the configuration on the computer.
 - ▶ Open menu **Target** and select **Update Firmware**.
 - ▶ Select the update file.
 - Firmware of the connected device is updated.
 - ▶ In the status window check if the update is completed successfully.
 - ▶ If the device was updated from V5 to V6 , select **V6** in drop-down list **Select device version**.
 - ▶ If using a V5 configuration, open menu **File** and select **Convert V5 to V6** to convert the configuration to the latest version.
 - ▶ Write the saved configuration to the device.



HMS recommends to verify configurations that are converted from V5 to V6, to make sure that all settings are working correctly.

6 Configuration



The security settings set via the CAN-Gateway Configurator define if changing the configuration via Ethernet is possible and if a password is needed to change to configuration. The default password is IXXAT. For more information see user manual *CAN-Gateway Configurator*.

6.1 Connecting Possibilities (CAN@net NT with PC)



Connection disturbance possible if extension cable or longer cable is used!
HMS recommends connecting the interface directly with the included cable or via an active USB hub to the computer according to the USB specification.

There are different possibilities to connect the CAN@net NT with the PC. Depending on the type of connection different ways of configuring the IP address and the device are necessary.

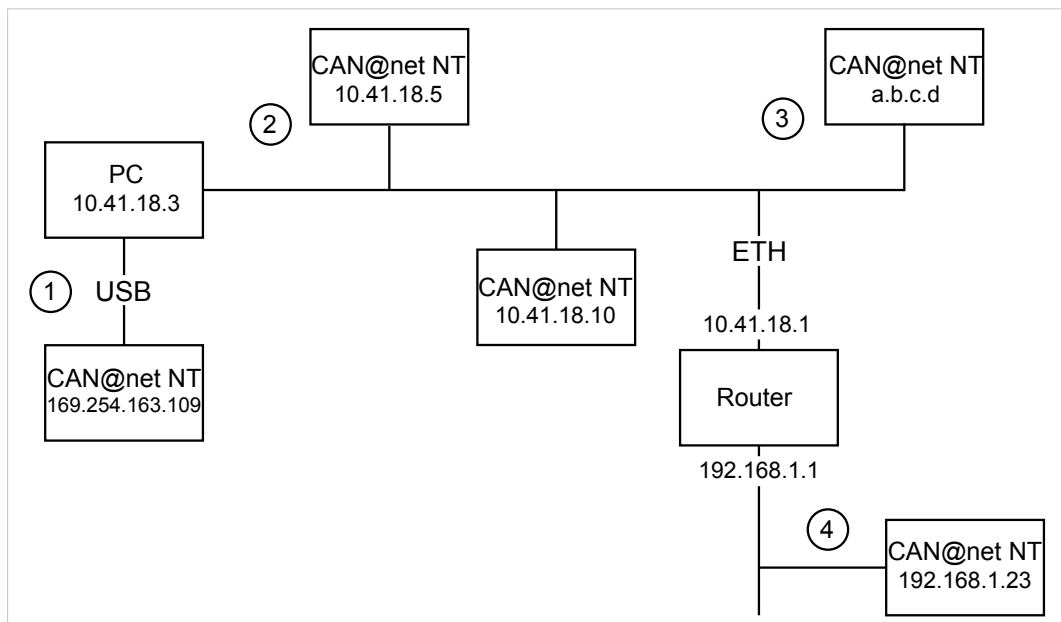

Fig. 5 Types of connection

The following ways of connecting the devices with the PC for the configuration are possible:

- **(1)** via USB (recommended for the first configuration of the device)
- **(2)** via Ethernet in a local network
- **(3)** via Ethernet in a local network with an unknown or invalid IP address
- **(4)** via Router (IP address of device has to be known)

For information how to access the device for configuration see [Connecting the Device in the CAN-Gateway Configurator, p. 16](#).

6.2 Basic Configuration

i It is possible to add information about the configuration in fields **Author**, **Configuration Name** and **Additional Info** in the configuration tree entry **Info**.

i It is possible to create and save a configuration without a connected device. Saved configurations can be downloaded to connected CAN NT devices with Windows and Linux by using the Command Line Tool (see [Downloading the Configuration with Linux](#), p. 22).

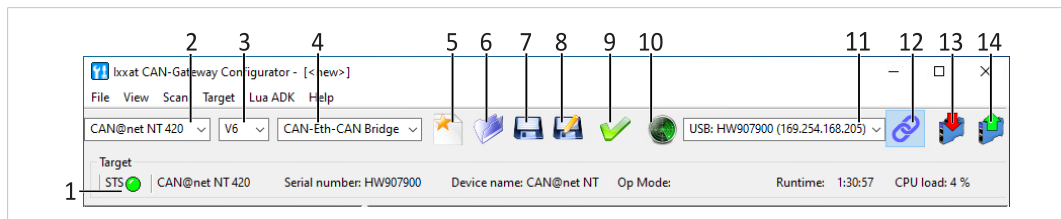

Fig. 6 CAN-Gateway Configurator

1	Information about target device (STS reflects Power LED of device)
2	Drop-down list Select device type
3	Drop-down list Select device version
4	Drop-down list Select operational mode
5	Button New
6	Button Open
7	Button Save
8	Button Save as
9	Button Verify
10	Button Scan
11	Combo box Target device
12	Button Connect
13	Button Write to
14	Button Read from

6.2.1 Connecting the Device in the CAN-Gateway Configurator

! The different CAN@net NT types 100, 200 and 420 can not be combined. For CAN-Ethernet-CAN Bridges use either NT 100 devices, NT 200 devices, or NT 420 devices.

To use all features the latest firmware versions of the CAN-Gateway Configurator and the CAN@net NT must be installed.

- ▶ Make sure, that the latest VCI driver is installed.
- ▶ Make sure, that the device is installed correctly (see [Installing the Hardware](#), p. 11).
- ▶ Connect a device to the host computer (see [Connecting Possibilities \(CAN@net NT with PC\)](#), p. 15).
- ▶ Make sure, that the latest firmware is on the device (see [Checking and Updating the Firmware](#), p. 13).
- ▶ Make sure, that the latest CAN-Gateway Configurator is installed (check within product support pages on www.ixxat.com/suppor-bridges-gateways).
- ▶ Start the CAN-Gateway Configurator.

- ▶ To identify the connected devices and the firmware version, open menu **Scan** and select **All Ixxat devices**.
 - Via USB and Ethernet connected devices and firmware version of the devices are shown.
 - Devices with an unknown or invalid IP address are not found.

If a device that is connected via Ethernet in a local network is not found:

- ▶ See [Scanning for Devices with Unknown IP Addresses, p. 18](#) for more information.

If device is connected via a router, USB, or Ethernet in a local network:

- ▶ Select the type of CAN@net NT in use in drop-down list **Select device type (2)**.
- ▶ Select the firmware version of the device in drop-down list **Select device version (3)**.
- ▶ Select the desired operational mode for the device in use in drop-down list **Select operational mode (4)**.
- ▶ If the device is connected via a router, enter the IP address (see [Default Network Settings, p. 28](#)) in combo box **Target Device (11)**.

or

If device is connected via USB or Ethernet, click button **Scan (10)** and select the device in use in combo box **Target Device (11)**.

- ▶ Click button **Connect (12)** to connect the selected device.
- ▶ For ASCII Gateway and VCI Interface mode make sure that the IP address is in the range of the network in which the device is integrated (see [Changing IP Address and Device Name, p. 19](#)).
- ▶ For CAN-Ethernet-CAN bridge make sure that the IP addresses of all devices of the bridge are in the same IP range (see [Changing IP Address and Device Name, p. 19](#)).
- ▶ To create a new project file, click button **New (5)**.

or

To change an existing configuration, click button **Read from (14)** and save the configuration.

- ▶ Configure the device in the selected mode (see [Configuration of Interface Modes \(ASCII, VCI, ECI\), p. 20](#) or [Configuration of Bridge Modes \(Local CAN, CAN-Eth-CAN\), p. 21](#)).

6.2.2 Scanning for Devices with Unknown IP Addresses

If the IP address of a device that is connected via Ethernet is unknown or invalid in the local network, the device can be found via menu **Scan — IP configuration**.



Device is only found by scanning, if correct device type and firmware version are selected. Make sure, that device type and firmware version are selected according to the connected device.



HMS Industrial Networks recommends to use a static IP address.

- ▶ Select the type of CAN@net NT in use in drop-down list **Select device type (2)**.
- ▶ Select the firmware version of the device in drop-down list **Select device version (3)**.
- ▶ Open menu **Scan** and select **IP configuration**.
 - CAN-Gateway Configurator scans automatically for connected devices of predefined type and firmware version.
 - Connected devices of the selected type and firmware version are shown.

Fig. 7 IP configuration

- ▶ Select the desired device in the drop-down list **Target device**.
- ▶ If necessary define a new IP address.
- ▶ Make sure that the IP address is in the range of the network in which the device is integrated.
- ▶ Define the network settings.
- ▶ Enter password (default: IXXAT) in field **Device password**.
- ▶ To write the new IP configuration to the target device click button **Save**.
- ▶ Connect the device in CAN-Gateway Configurator (see [Connecting the Device in the CAN-Gateway Configurator, p. 16](#)).

6.2.3 Changing IP Address and Device Name



HMS Industrial Networks recommends to use a static IP address.

- ▶ Make sure that the device is connected in the CAN-Gateway Configurator (see [Connecting the Device in the CAN-Gateway Configurator, p. 16](#)).
 - ▶ Open menu **Target** and select **Change IP configuration**.
 - Window **IP Configuration** is opened.
 - ▶ Make sure that the serial number in drop-down list **Target device** points to the connected device.
 - ▶ To change the IP address, define the network settings.
 - ▶ To change the device name, enter a new device name in field **Device name**.
 - ▶ Enter password (default: IXXAT) in field **Device password**.
 - ▶ To write the new IP configuration to the target device click button **Save**.
 - ▶ Connect the device again in CAN-Gateway Configurator (see [Connecting the Device in the CAN-Gateway Configurator, p. 16](#)).
-



HMS Industrial Networks recommends to change the default password. See User Manual CAN-Gateway Configurator for more information.

6.3 Configuration of Interface Modes (ASCII, VCI, ECI)



The VCI interface mode can only be operated via Ethernet. Configuration is possible via USB.

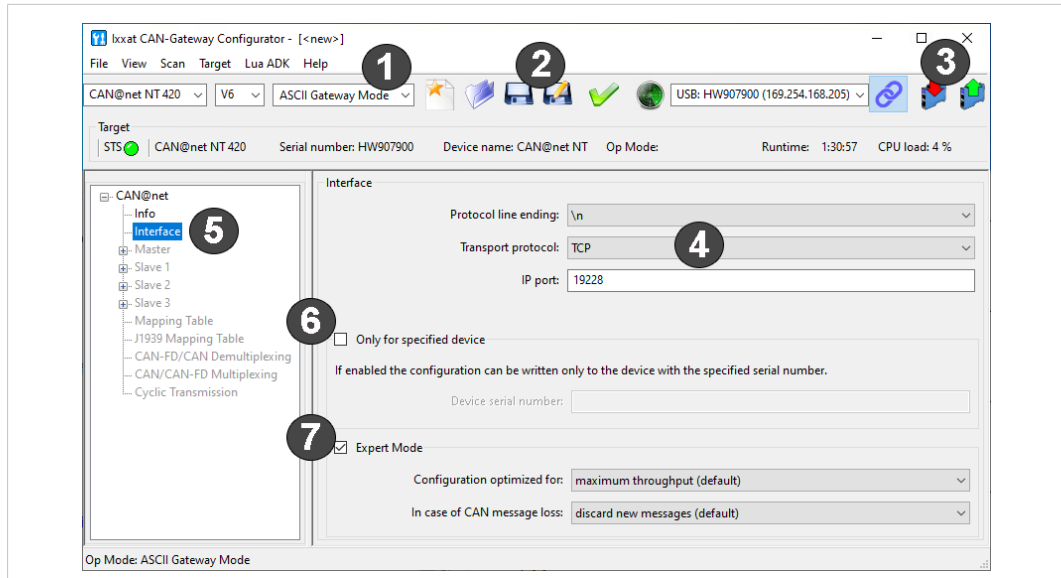

Fig. 8 ASCII Gateway Mode

- ▶ Make sure, that the device is connected to the network (see [Connecting Possibilities \(CAN@net NT with PC\)](#), p. 15) and to the CAN-Gateway Configurator (see [Connecting the Device in the CAN-Gateway Configurator](#), p. 16).
- ▶ In drop-down list (1) select the desired interface operational mode.
- ▶ In the configuration tree (5) select **Interface**.
- ▶ If checkbox **Only for specified device** (6) is enabled, enter the serial number of the device to which the configuration can be written.

If ASCII Gateway Mode is selected:

- ▶ Configure the protocol line ending (4).
 - ▶ Define the transport protocol (default TCP).
 - ▶ If UDP is selected, make sure that UDP is also used on the client side.
 - ▶ Define the IP port (4).
 - ▶ If checkbox **Expert Mode** (7) is enabled, select the desired settings (for more information see User Manual *CAN-Gateway Configurator*).
 - ▶ To write the configuration to the device, click button **Write to** (3).
- or
- ▶ Click button **Save** or **Save as** (2) to save the configuration.
 - ▶ To exchange messages in the Gateway mode, use ASCII commands (for more information see Software Design Guide *CAN@net NT 100/200/420 Generic Protocol for Gateway Mode* on product support pages on www.ixxat.com/support-bridges-gateways).
 - ▶ In the VCI interface mode configure the Device Server (for more information see Installation Guide VCI Driver included in VCI download package on www.ixxat.com/windows-driver).
 - ▶ In the ECI interface mode see Software Design Guides in the ECI download package (included in ECI download package on www.ixxat.com/windows-linux) for information about the communication in the ECI mode and commands that are used to exchange CAN messages.

6.4 Configuration of Bridge Modes (Local CAN, CAN-Eth-CAN)

i In the CAN-Ethernet-CAN Bridge mode each device can be configured differently. But to build a Bridge configuration all devices must be configured in one configuration file. The configuration has to be set completely for all devices (Master, Slave 1 to 3) and then the complete configuration has to be downloaded to each device. In the Local CAN Bridge mode only one device is connected and has to be configured.



Exclusively one master device is allowed in the Bridge mode.

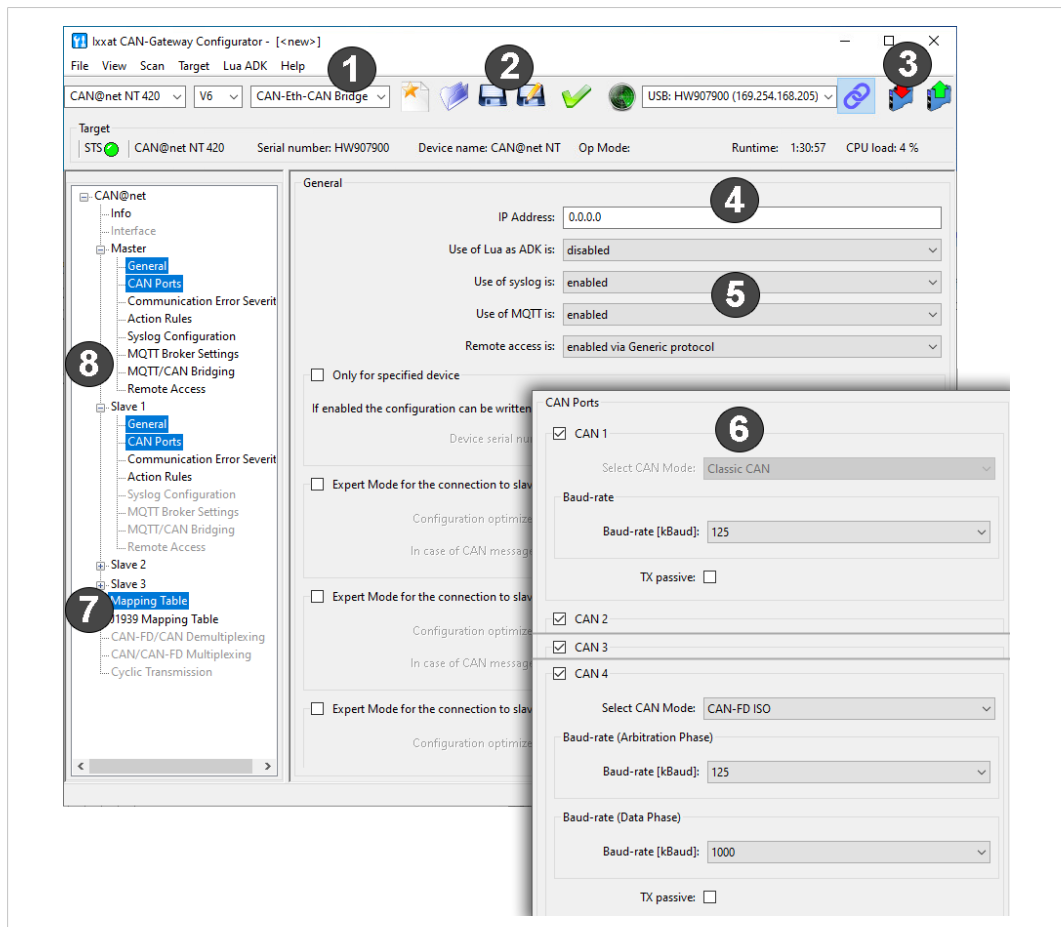

Fig. 9 CAN-Gateway Configurator CAN@net NT 420

For more information about the setting possibilities (e.g. general settings, baud rate, MQTT) and descriptions of the further configuration possibilities (e.g. J1939 Mapping, cyclic transmission) see User Manual *CAN-Gateway Configurator* on www.ixxat.com/support-bridges-gateways.

- ▶ Make sure, that the Master device is connected to the network (see *Connecting Possibilities (CAN@net NT with PC)*, p. 15) and to the CAN-Gateway Configurator (see *Connecting the Device in the CAN-Gateway Configurator*, p. 16).
- ▶ In drop-down list (1) select the desired bridge operational mode.

- ▶ Configure the following for the Master and for each Slave in use:
 - ▶ In the configuration tree select **General (8)** and enter the IP address of the device for CAN-Ethernet-CAN bridges **(4)**.
 - ▶ Define the general settings **(5)**.
 - ▶ In the configuration tree select **CAN Ports (8)** and configure the baud rate settings for all ports in use **(6)**.
 - ▶ Configure further settings if desired (MQTT, Syslog, Action Rules, etc.) **(8)**.
- ▶ Configure the mapping table **(7)**.



Only messages that are entered in the mapping table are forwarded. By default, no filter is set and all messages are rejected.

- ▶ To write the configuration to the device, click button **Write to (3)**.
or
- ▶ Click button **Save** or **Save as (2)** to save the configuration.
- ▶ For the CAN-Ethernet-CAN Bridge connect the devices one after another and download the configuration to each device.
- ▶ Observe that for the configuration of a CAN-Ethernet-CAN Bridge each device must be configured with the same configuration file. If the configuration is changed, the new configuration file has to be downloaded again to all devices.

6.5 Downloading the Configuration with Linux

The basic configurations, like the selection of the operating mode, can only be created with the CAN-Gateway Configurator with Windows. A configuration can be created and saved without a connected device and can then be downloaded to connected CAN NT devices with Linux by using the Command Line Tool that is included in the scope of delivery.

- ▶ To be able to read and write configurations on CAN NT devices, copy the included file *60-bgi.rules* to the folder `/etc/udev/rules.d/` (root access required).
- ▶ To activate the new rules, execute the following command:

```
udevadm control --reload-rules
```

- ▶ To download a saved configuration file to CAN NT devices, start the Command Line Tool *cangwfile* without parameters.
 - Output shows the syntax, examples and all possible commands.
- ▶ Write the configuration to the target device (see User Manual *CAN-Gateway Configurator* for more information about the Command Line Tool).

6.6 Reset

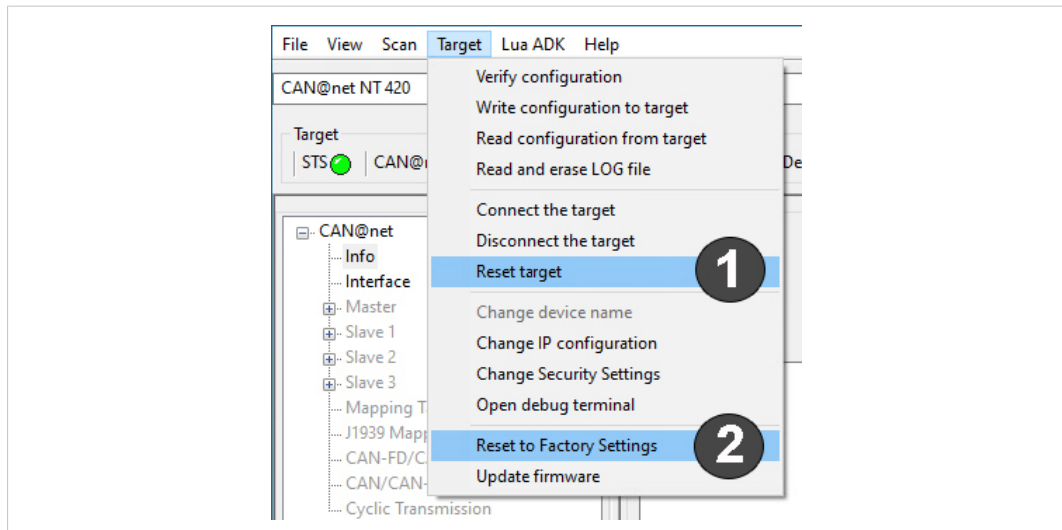

Fig. 10 Reset

6.6.1 Reset Target

With **Reset target (1)** it is possible to restart the device without reset the configuration.

- ▶ Open menu **Target** and select **Reset target**.
 - Device is restarted (software of the device).
 - Connection to the CAN-Gateway Configurator is lost.

6.6.2 Reset to Factory Settings

With **Reset to Factory Settings (2)** it is possible to reset the configuration of a connected device to factory settings.

- ▶ Make sure that the device is connected via USB.
- ▶ Open menu **Target** and select **Reset to Factory Settings**.

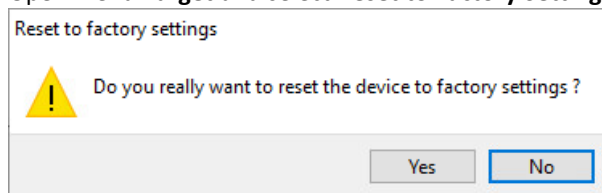

- ▶ Click button **Yes** to confirm the reset.
 - Configuration is reset to factory settings.
 - Connection to the CAN-Gateway Configurator is lost.

6.7 Read and erase LOG File

In case of an error the device writes the error in a log file. The log file can be read from the device, saved as a txt file and send to the Ixxat support if needed.

- ▶ Open menu **Target** and select **Read and erase LOG file**.
 - Window **Save Log File As** is opened.
- ▶ Define a file name and save the file.
 - .txt-file is created and saved.
 - Configuration file is saved.

7 Operation

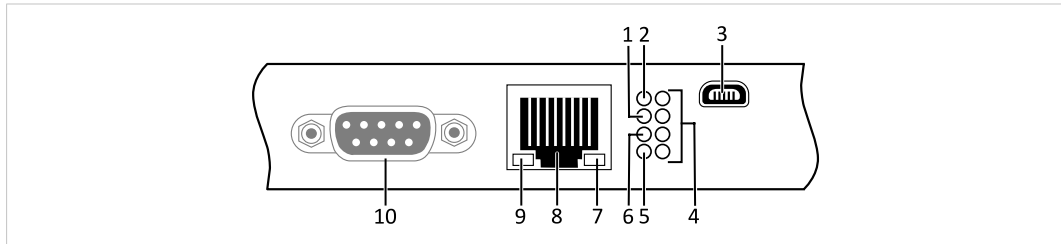

Fig. 11 Ports and LEDs

1	Status LED
2	Power LED
3	Mini USB port
4	CAN LEDs 1 to 4
5	User LED
6	Ethernet LED
7	Link speed LED
8	Ethernet port
9	Link/Activity LED
10	CAN connector D-Sub 9 (CAN@net NT 100)

7.1 Ethernet Port

Designed as standard RJ45 port with pin allocation according to Ethernet standard. Because of the Ethernet PHY auto-crossover feature the device can be connected with a crossover cable or with a one-to-one network cable.

The shield of the port is connected to the ground of the printed board via a 1 nF capacitor.

Pin Allocation Ethernet Port

Pin no.	Signal
1	TX+
2	TX-
3	RX+
4	Connected to pin 5
5	Connected to pin 4
6	RX-
7	Connected to pin 8
8	Connected to pin 7

7.2 Mini USB Port

Provided to connect the device for configuration.

7.3 Indicators

7.3.1 Power LED

Indicates the status of the power supply.

LED state	Description	Comments
Off	No power	Possible causes: device not connected to power supply, fuse of device damaged, internal power supply damaged, power supply not sufficient
Green	Power	Device fully functional

7.3.2 Status LED

Indicates the device status.

LED state	Description	Comments
Off	Device not ready	No firmware, application firmware not started
Green flashing (1 Hz)	Application firmware started	Device in <i>Operational</i> state
Red/green flashing	Configuration file error	Rewriting of configuration to device necessary
Green/orange flashing	Device in <i>Configuring</i> state	In <i>Configuring</i> state the device read the configuration from the local file system. In operating mode CAN-ETH-CAN Bridge the device tries to establish the connection to the slaves. If a slave is missing, the device stays in <i>Configuring</i> state.
Orange flashing (1 Hz)	Automatic baud rate detection or Lua ADK in remote mode	Ongoing automatic baud rate detection, or Lua ADK in remote mode
Red flashing	Device error	Application signals a device error, error in configuration or no configuration. Read log file for more information (see Read and erase LOG File, p. 24).

7.3.3 User LED

Indicates the primary application status and is different, depending on the operating mode.

Bridge

In the Bridge mode the User LED can be configured with user defined settings via Action Rules. See User Manual *CAN-Gateway Configurator* for more information.

VCI Interface

The User LED is not used.

ASCII Gateway

LED state	Description	Comments
Orange/Green flashing	No connection monitoring	—
Green flashing	Connection monitoring activated	Heartbeat mechanism to monitor the connection (PING REQUEST, PING RESPONSE)

7.3.4 Ethernet LED

Indicates the Ethernet communication status.

LED state	Description	Comments
Off	No Ethernet communication	Possible causes: device unsuccessfully initialized, device not connected to Ethernet or no communication
Green flashing	Data packet transmitted successfully	Communication was successful
Orange flashing	Data packet not transmitted Congestion	Bad or slow connection, messages can not be transmitted to CAN and are jammed

7.3.5 Link Speed LED

The yellow LED indicates the link speed.

LED state	Description
Off	10 MBit/s
Orange	100 MBit/s

7.3.6 Link/Activity LED

Indicates connection status of the Ethernet interface.

LED state	Description	Comments
Off	No link detected	No connection to Ethernet network, Network cable damaged
Green	Link	Ethernet connection established, no communication present
Green flashing	Activity	Ethernet connection established, communication present

7.3.7 CAN LED

CAN 1-4 LEDs indicate the status of the corresponding CAN interface.

LED state	Description	Comments
Off	No CAN communication	No connection to CAN
Orange flashing	Indicates a state of the automatic baud rate detection	See User Manual <i>CAN Gateway Configurator</i>
Green flashing	CAN communication	LED is triggered with each CAN message
Green	CAN communication	Device in <i>Operational</i> state, no messages on CAN bus
Red flashing	CAN communication, CAN controller in <i>Error</i> state	CAN controller in <i>Error Warning</i> or <i>Error Passive</i> state, reception/transmission of CAN messages possible
Red	Bus off	CAN controller is in <i>Bus Off</i> state, no CAN communication possible

8 Default Network Settings

Network parameter	Default setting	Remark
IP Mode	Static	
IP Address	169.254.y.x y = ((device serial number - 800 000) DIV 254) MOD 256 x = ((device serial number - 800 000) MOD 254) +1	Like APIPA if no DHCP server is available. By scanning the network, all available devices can be found.
Subnet Mask	255.255.0.0	
Standard Gateway	0.0.0.0	
Device Name	CAN@net NT	
Device password	IXXAT	Transmitted MD5-encrypted

9 Default TCP/UDP Ports

	CAN@net	PC
CAN Gateway Configurator	Device scan and IP configuration: 15000/udp Device configuration (via TCP): 19229/tcp	Device scan and IP configuration: 15001/udp Device configuration (via TCP): 1024-65535/tcp
VCI	19229/tcp	1024-65535/tcp
Gateway (ASCII Interface)	19228/tcp, udp 1024-65535/tcp, udp	1024-65535/tcp
Bridge (CAN-Ethernet-CAN)	Slave: 19239/tcp Master: 1024-65535/tcp	—

10 Technical Data

Ethernet Interface	10/100 Mbit/s, twisted pair
Dimensions	114.5 x 99 x 22.5 mm
Weight	Approx. 150 g
Operating temperature	-40 °C to +85 °C
Storage temperature	-40 °C to +85 °C
Power supply	9 V to 36 V DC with overvoltage and polarity protection
Current consumption	Typically 110 mA at 24 V input voltage, typically 230 mA at 12 V input voltage
Housing material	Polyamide
Galvanic isolation	1 kV DC for 1 sec
Protection class	IP20
CAN bit rates (CAN1/CAN2)	5 kbit/s to 1000 kbit/s
CAN FD bit rates (CAN3/CAN4 with CAN@net NT 420)	Arbitration rate: up to 1000 kbit/s, data rate: up to 8000 kbit/s (verified by testing) User defined bit rates are possible. Depending on the operating conditions (cable length, settings made, remote stations, etc.) the maximum data might not be reached or exceeded.
CAN FD controller/clock frequency (CAN3/CAN4 with CAN@net NT 420)	IFI CAN_FD IP/80 MHz
Max. number of bus nodes	120
CAN bus termination resistor	None
CAN pass through delay	Local CAN Bridge: 25-50 µs depending on configuration settings and CAN load CAN-Ethernet-CAN Bridge: 4-6 ms

Processing performance in Bridge mode	30 000-40 000 msg/s
Startup time after power on	Min. 250 ms (configuration size 5 kB), max. 790 ms (configuration size 140 kB) Ethernet connection might add up to 1–2 seconds

11 Support/Return Hardware

11.1 Support

- ▶ To contact support, go to www.ixxat.com/technical-support/contact-technical-support.
- ▶ Scroll down and click button **mysupport.hms.se** to register a support case.

11.2 Return Hardware

- ▶ On www.ixxat.com/support/product-returns click button **Portal** to access the support portal.
- ▶ In the support portal select **Submit Product Return (RMA)**.
- ▶ Read the information and click **Create RMA Case**.
- ▶ Register a support account and sign in.
- ▶ Fill in the form for warranty claims and repair.
- ▶ Print out the Product Return Number (PRN resp. RMA).
- ▶ Pack product in a physically- and ESD-safe way, use original packaging if possible.
- ▶ Enclose PRN number.
- ▶ Observe further notes on www.ixxat.com.
- ▶ Return hardware.

12 Disposal

- ▶ Dispose of product according to national laws and regulations.
- ▶ Observe further notes about disposal of products on www.ixxat.com.

This page intentionally left blank

A Regulatory Compliance

A.1 EMC Compliance (CE)



The product is in compliance with the Electromagnetic Compatibility Directive. More information and the Declaration of Conformity is found at www.ixxat.com.

A.2 EMC Compliance (UKCA)



The product is in compliance with the Electromagnetic Compatibility Regulations 2016. The Declaration of Conformity is available at www.ixxat.com

A.3 FCC Compliance Statement

This device complies with Part 15 of the FCC Rules. Operation is subject to the following two conditions:

- This device may not cause harmful interference.
- This device must accept any interference received, including interference that may cause undesired operation.

Product name	CAN@net NT
Model	100/ 200/420
Responsible party	HMS Industrial Networks Inc
Address	35 E. Wacker Dr, Suite 1700 Chicago , IL 60601
Phone	+1 312 829 0601



Any changes or modifications not expressly approved by HMS Industrial Networks could void the user's authority to operate the equipment.



This equipment has been tested and found to comply with the limits for a Class B digital device, pursuant to Part 15 of the FCC rules. These limits are designed to provide reasonable protection against harmful interference in a residential installation. This equipment generates, uses and can radiate radio frequency energy and, if not installed and used in accordance with the instructions, may cause harmful interference to radio communications. However, there is no guarantee that interference will not occur in a particular installation. If this equipment does cause harmful interference to radio or television reception, which can be determined by turning the equipment off and on, the user is encouraged to try to correct the interference by one or more of the following measures:

Reorient or relocate the receiving antenna.

Increase the separation between the equipment and the receiver.

Connect the equipment into an outlet on a circuit different from that to which the receiver is connected.

Consult the dealer or an experienced radio/TV technician for help.

A.4 Disposal and recycling



You must dispose of this product properly according to local laws and regulations. Because this product contains electronic components, it must be disposed of separately from household waste. When this product reaches its end of life, contact local authorities to learn about disposal and recycling options, or simply drop it off at your local HMS office or return it to HMS.

For more information, see www.hms-networks.com.

B UL Ordinary Locations (Ord.Loc.)

CAN@net NT devices are certified for use in ordinary locations in compliance with the following standard:

- UL 62368-1 & CAN/CSA C22.2 No. 62368-1-14, Audio/video, information and communication technology equipment Part 1: Safety requirements

The certification number of the certified devices according to OrdLoc certification is:

- E466303

According to the standards listed above, the devices are certified with the following marking:



Intended Use

The components are used to connect computer systems to CAN and CAN FD networks and to connect the networks with each other. They are intended for installation on standard DIN rail.



Risk of interference to radio and television if used in office or home environment!

Use exclusively included accessories. Use exclusively shielded cables.

Make sure that the shield of the interface is connected with the device plug and the plug on the other side.



Protect product from moisture and humidity.

Protect product from too high or too low temperature, and from fire.

Utilisation prévue

Les composants sont utilisés pour connecter les systèmes informatiques aux réseaux CAN et CAN FD et pour connecter les réseaux entre eux. Ils sont destinés à être installés sur un rail DIN standard.



Risque d'interférence avec la radio et la télévision si elles sont utilisées au bureau ou à la maison !

Utilisez exclusivement les accessoires inclus. Utilisez exclusivement des câbles blindés.

Vérifiez que le blindage de l'interface est connecté avec la prise de l'appareil et la prise de l'autre côté.



Protégez le produit de l'humidité.

Le produit ne doit pas être soumis à des températures extrêmes et doit être protégé contre tout risque d'incendie.

